

# TRAILBOSS

## Towbar Fitting Instructions To Suit **HYUNDAI ELANTRA 2012 ON** Part Number **HY28L** Rating **800/80 kg**

PLACE THESE INSTRUCTIONS IN THE VEHICLE'S GLOVEBOX AFTER INSTALLATION IS COMPLETE

### **WARNING:**

1. Do not, drill, cut, weld or otherwise modify the tow bar.
2. If you are using electric welding on a motor vehicle, **always** check that the vehicle is not equipped with electronic engine or instrument management equipment. Failure to do so could **destroy** any onboard computers. If in doubt, check with the vehicle's manufacturer.
3. The high tensile fasteners supplied with this product were used to achieve the specified rating. If replacement is required ensure that fasteners of the same rating & quality are used. Contact an authorised **Trailboss** dealer if further information is required.

### **General:**

1. Ensure all hardware items have been included refer to assembly diagram.
2. It is recommended that the instructions are read through and completely understood before making any attempt to fit this product.
3. Be wary of any changes to vehicle designs or other accessories that may conflict with the installation of this product.
4. Before drilling ensure that the area is clear of fuel, electrical & other components.
5. All holes drilled into the body panels shall have all burrs & swarf removed then coated with a suitable rust preventative paint.
6. For vehicles that require the bumper to be cut. Ensure cut out area is in correct position on the vehicle prior to cutting the bumper.
7. The high tensile fasteners supplied with this product were used to achieve the specified rating. If replacement is required ensure that fasteners of the same rating & quality are used. Contact an authorized **Trailboss** dealer if further information is required.
8. Ensure that all hardware is fastened to torque list below check fasteners on regular basis.
9. Tow bar load rating sticker provided with this product shall be conspicuously located on inside rear end of the driver's door. **(See diagram below)**.
10. Trailboss recommends that you check your tow ball to ensure that it complies with the Australian standards **AS 4177.2**.
11. **PLEASE NOTE:** It is advised to remove your lug or tbm when not actually towing so as to produce a clear view of the vehicles registration plate if obscured, and to also provide maximum available departure angle
12. Pull Pin must be fit in down position.

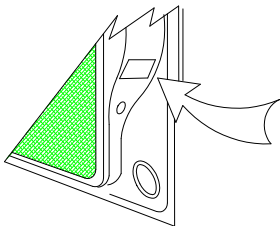

Place load rating sticker  
inside driver's door here

**FOR TRAILER TOWING PURPOSES ONLY**  
For towing capacity details please refer to vehicle owner's manual or to the manufacturer. Overloading can void your warranties.

#### **RECOMMENDED ASSEMBLY TORQUE LISTING**

<u>Diameter</u>	<u>Grade 8.8 Bolt</u>
M6	9.5 Nm
M8	21.7 Nm
M10	43.4 Nm
M12	77.3Nm
M14	146 Nm
M16	189.8 Nm

### **Tow bar Maintenance and Care.**

Trailboss recommends that bolt torque's, as listed below, are routinely and regularly inspected and checked for correct tension. Replace any worn or defective parts.

We recommended to remove Tow Ball Mounts (TBM's, tongues or lugs) when not being used for any considerable length of time.

So as to avoid injury, when not towing it is suggested that the tongue, Pull Pin and R-clip are removed then stored in a safe, clean and dry place, away from excessive moisture.

Hitch Pull Pins and spring "R" clips are regularly checked for proper installation. Replace any worn or defective parts.

# TRAILBOSS

Towbar Fitting Instructions  
 To Suit **HYUNDAI ELANTRA 2012 ON**  
 Part Number **HY28L**  
 Rating **800/80 kg**

PLACE THESE INSTRUCTIONS IN THE VEHICLE'S GLOVEBOX AFTER INSTALLATION IS COMPLETE

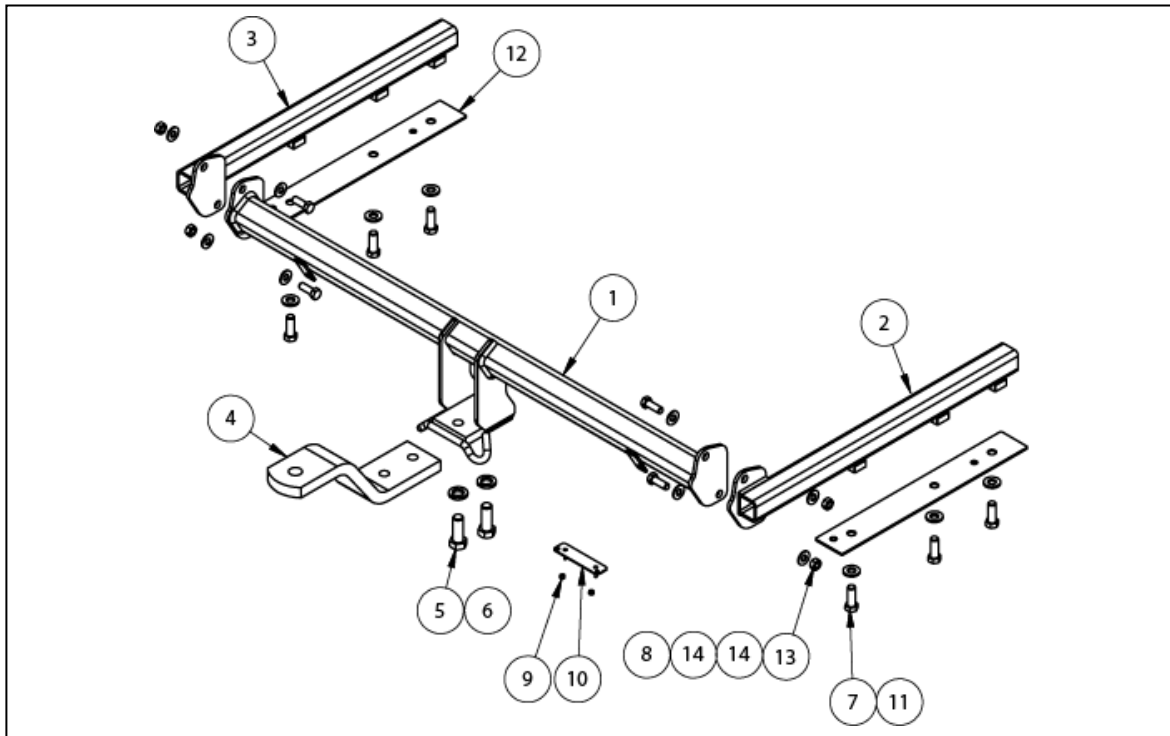

QTY	DESCRIPTION	ITEM NO.
1	TOWBAR CENTRE SECTION	1
1	CHASSIS INSERT RHS	2
1	CHASSIS INSERT LHS	3
1	LUG	4
2	M16x45x2.0P BOLT	5
2	M16x5x3.5 SPRING WASHER	6
6	M12x35X1.75P BOLT	7
4	SET SCREW HEX HD M10x30x1.5P	8
2	NUT NULOC M4-0.7 Z/P	9
1	PLUG BRACKET	10
6	WASHER FLAT ½" x1 1/8" x1/8"	11
2	WASHER PLATE	12
4	HEX NUT M10x 1.5	13
8	WASHER FLAT M10x23x2	14

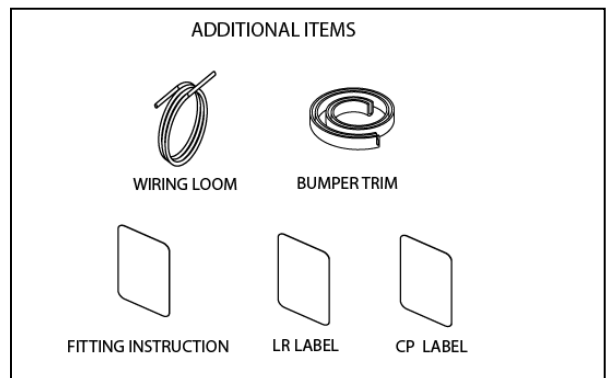

# TRAILBOSS

Towbar Fitting Instructions  
To Suit **HYUNDAI ELANTRA 2012 ON**  
Part Number **HY28L**  
Rating **800/80 kg**

PLACE THESE INSTRUCTIONS IN THE VEHICLE'S GLOVEBOX AFTER INSTALLATION IS COMPLETE

## INSTRUCTION:

1. Remove 3 Plastic Scrivets from inside of rear Wheel Arc for both LH & RH side.
2. Remove 6 Scrivets from under side of Bumper Bar for LH and 2 Scrivets for RH side.
3. Remove all inside paneling from inside of Boot.
4. Disconnect rear light Plug and remove 3 Nuts then remove rear light.
5. Remove 2 Scrivets and 1 Screw.
6. Remove 2 Bolts from Impact Beam for both LH &RH side. Firmly pull on Bumper to remove from Clips.
7. Remove all Scrivets connecting the Impact Beam to the Bumper and also remove and keep the bottom LH &RH side Brackets from the Impact Beam and discard the rest.
8. Drop the Exhaust Muffler from its rubbers and remove 2 Nuts from Heat Shield also remove 2 Grommets from Chassis Rail for both LH &RH side.
9. Drill a  $\varnothing$ 14mm hole in the middle of the bottom face of the chassis rail at a distance of 142mm away from the back panel.
10. Insert the two chassis insets and loosely bolt them in.
11. Offer the centre section of the bar to the car and bolt together. Tighten all Bolts to Torque Specifications provided.
12. Make a bumper cut in the middle of the bottom face of the Bumper Bar 95mm Wide and 105mm high. Reassemble Vehicle in reverse order to disassembly.

**NOTE:** Reuse bumper Brackets that were taken off from the Impact beam in step8.

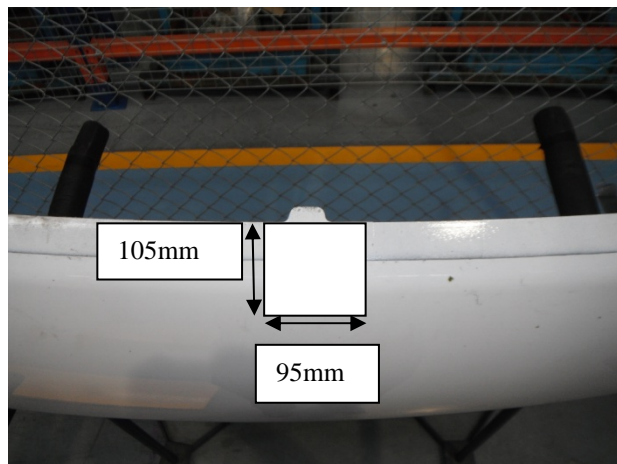



Wiring Loom Fitting Instructions  
To Suit Hyundai YF i45 / MD Elantra  
Part Number 100382-WL

## Wiring Loom Installation Instructions

Hyundai YF i45 / MD Elantra  
Part No: 100382-WL

Tail Harness Length Required: 1200mm

**Note: If factory OEM RPA is fitted, Trouble Code will be logged if disabled.**

Wiring Loom Installation Time: Approx 40 Mins



Wiring Loom Fitting Instructions  
To Suit Hyundai YF i45 / MD Elantra  
Part Number 100382-WL

1. In the luggage compartment, remove the floor carpet.
2. Remove the rear trim by first removing the two fasteners.

**Step 3 is for Hyundai YF i45 models only.**

3. On the RHS of the luggage compartment, remove the rear storage tray by first removing the fasteners.
4. Remove the LHS panel.
5. Remove the cargo hook.
6. Remove the LHS side trim by first removing all the clips.

**Note: One clip is located behind the rubber lining.**

**Repeat for the RHS.**

7. Locate and remove the two 12mm bolts in between the rear seat cushions.
8. Remove the lower seat cushions.

**Step 9 is for Hyundai YF i45 models only.**

9. Remove the bolt just underneath the RHS outer cushion.
10. Remove the RHS outer cushion.
11. Remove the RHS rear scuff trim by first removing the two screws.
12. Dislodge the RHS 'B' pillar trim.

**Steps 13&14 are for Hyundai MD Elantra models only.**

13. Remove the rear passenger backrest trim, by first removing the four clips.
14. Dislodge the luggage compartment lining by first removing the one clip.

**Step 15 is for Hyundai YF i45 models only.**

15. Remove the RHS front scuff plate.

# TRAILBOSS

## Wiring Loom Fitting Instructions To Suit Hyundai YF i45 / MD Elantra Part Number 100382-WL

**Step 16 is for Hyundai MD Elantra models only.**

16. Remove the RHS front door sill trim.
17. Remove RHS kick panel.
18. Remove the RHS outer dash trim.
19. Remove the fuse panel cover.
20. At the rear of the vehicle, drill the existing grommet hole out to  $\varnothing 30\text{mm}$ .
21. File down any rough or sharp edges and then spray with rust inhibitor.
22. In the LHS of the luggage compartment, following the table below, secure the supplied ezy-tap (1) onto the 'BLUE' reverse wire (2) and connect the trailer patch terminal (3) to the ezy-tap (1).

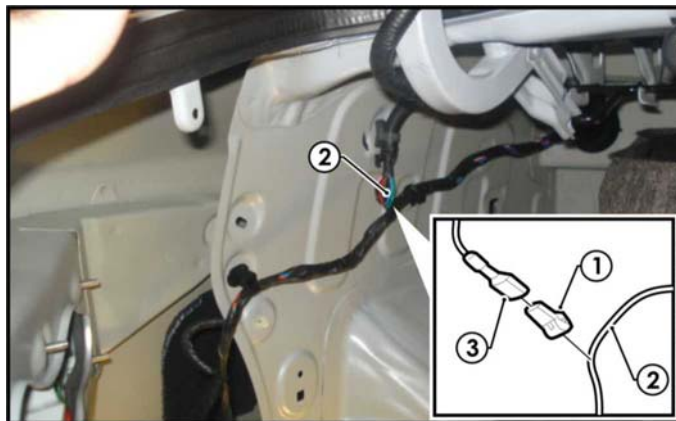

Function	Trailer Patch	Vehicle Connector
REVERSE	BLACK	BLUE

23. Disconnect the LHS tail light connector.
24. Connect the trailer patch harness to the LHS tail light and connect the LHS tail light connector to the trailer patch harness.
25. Route the trailer harness across the rear of the vehicle and towards the RHS.
26. Disconnect the RHS tail light connector.
27. Connect the trailer patch harness to the RHS tail light and connect the RHS tail light connector to the trailer patch harness.
28. Secure the trailer patch harness ground ring terminal to the vehicle sheet metal using a tech screw (not supplied).

# TRAILBOSS

## Wiring Loom Fitting Instructions To Suit Hyundai YF i45 / MD Elantra Part Number 100382-WL

29. Route the 'ORANGE' power wire along the existing vehicle harness towards the front of the vehicle past the 'B' pillar trim.
30. Continue routing the 'ORANGE' power wire along the existing vehicle harness towards the fuse panel.
31. Following the existing vehicle harness, route the power wire along the RHS, behind the 'B' pillar and towards the front of the vehicle.

**Steps 32-35 are for Hyundai YF i45 models only.**

32. Remove the indicated fuse (1) from the fuse panel.
33. Slot in the supplied 15-amp (2) fuse into the upper slot of the add-a-fuse (3) and connect the 30 amp (4) fuse in the lower slot of the add-a-fuse (3).
34. Insert the add-a-fuse (3) into the now vacant fuse slot.
35. Connect the trailer patch harness (5) to the add-a-fuse harness (6).

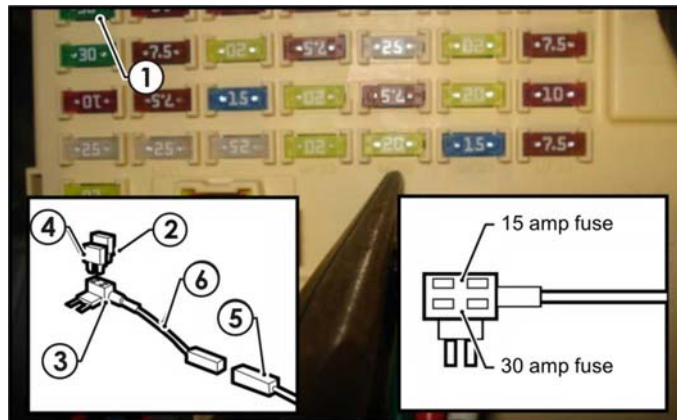

# TRAILBOSS

## Wiring Loom Fitting Instructions To Suit Hyundai YF i45 / MD Elantra Part Number 100382-WL

**Step 36-39 are for Hyundai MD Elantra models only.**

36. Remove the indicated 15-amp (1) spare fuse from the fuse box.

**Note: Refer to the back of the fuse box lid for indicated amp fuse location.**

37. Slot in the supplied 30-amp fuse (2) into the upper slot of the add-a-fuse (3) and connect the 15-amp fuse (4) in the lower slot of the add-a-fuse (3).

38. Insert the add-a-fuse (3) into the now vacant fuse slot.

39. Connect the trailer patch harness (4) to the add-a-fuse harness (5).

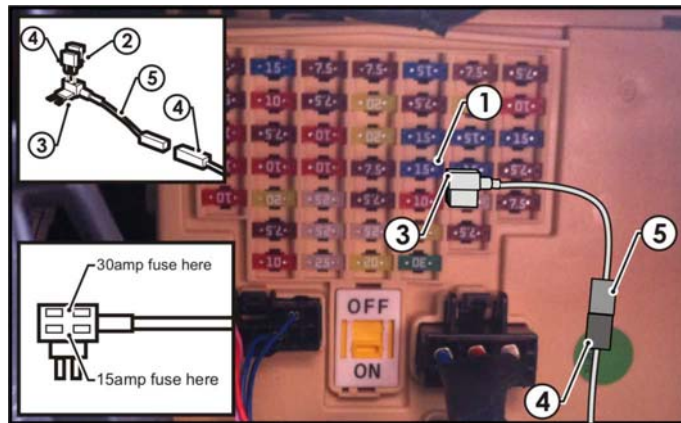

40. From the outside of the vehicle, mount the trailer socket on the towbar mounting bracket using M4 fasteners (not supplied).

41. Route the tail harness (tail length 1200mm) across the towbar, towards the LHS of the vehicle and up through the previously drilled out grommet hole.

42. In the luggage compartment, connect the tail harness connector to the trailer patch harness mating connector.

43. Test the Trailer Harness function using a Light Board or multimeter.

44. Secure all Harnesses using cables ties (not supplied).

45. Re-fit all removed parts and secure all fasteners, ensuring there are no squeaks or rattles.

46. Place the instructions in the glove box after fitment.